

# SMARTPONG

SMARTest ping PONG robot in the world



INSTALLATION AND TROUBLESHOOTING  
**BRIEF INSTRUCTION GUIDE**

# SMARTPONG

We appreciate very much for your purchase of the SMARTPONG

The microcomputer fully automatic table tennis robot.

For detailed information, please refer to the USER'S MANUAL.

## **Cautions:**

100 pieces of 40mm balls has been enclosed in packing carton.

When the balls are squished, please do not put it into machine to avoid damage.

When the balls are exhausted, buy 40mm balls.

## **Methods to Install Table Tennis Robot onto the Table**

1. When the table thickness is 25 mm use the No. 1 pad, when the table thickness is 21 mm use the No. 3/4 pad, when the table thickness is 17 mm use the No. 1/2 pad.
2. For trial shots, exercise the auto 1, auto 5 and auto 8 automatic mode to adjust to the appropriate frequency. If the balls do not fall upon the table, it means incorrect installation. Pads should be replaced by adequate ones or just put in pads and adjust until balls all fall upon table under auto 1, 5, 8 mode. Example for reference, shown as below:

AUTO 1      Frequency 20

AUTO 5      Frequency 15

AUTO 8      Frequency 5

# Steps to Install the Ball Blender Device to Prevent Balls from Obstructing

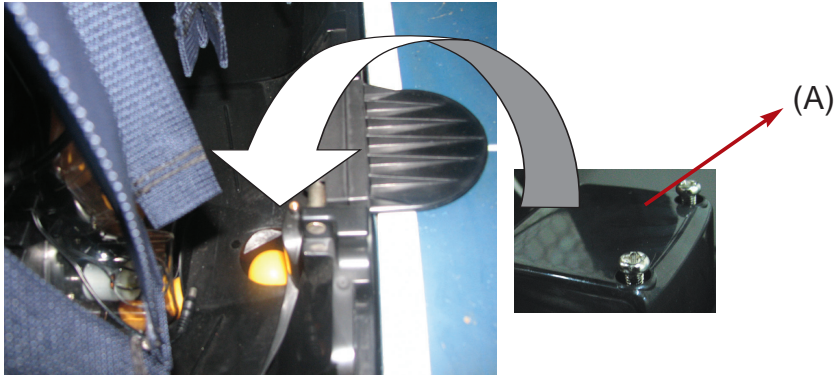
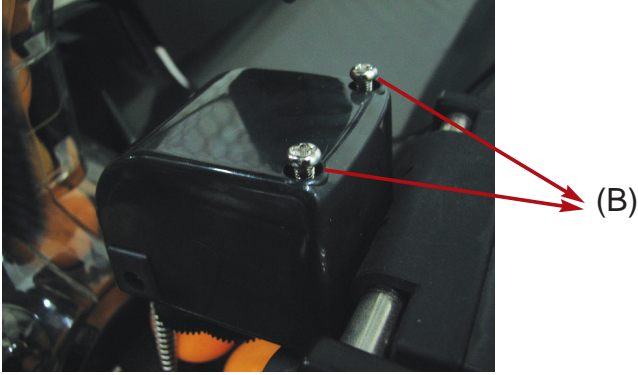
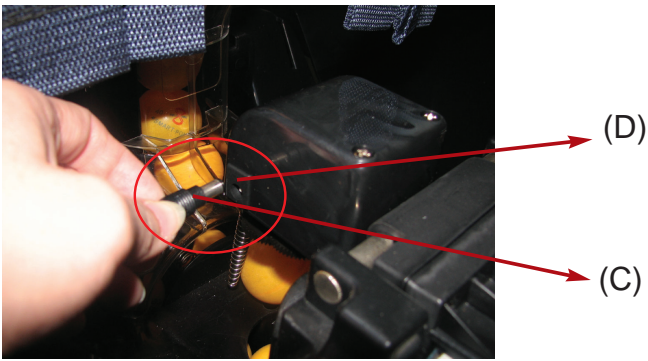
| <b>Operation instructions</b>                            | <b>ILLUSTRATE</b>                                                                    |
|----------------------------------------------------------|--------------------------------------------------------------------------------------|
| 1. Load motor (A) on the center trough of undercarriage. |    |
| 2. Put 2 screws (B) into the hole, then fasten them.     |   |
| 3. Put plug (C) into outlet (D).                         |  |

# Table Tennis Robot Assembly and Disassembly

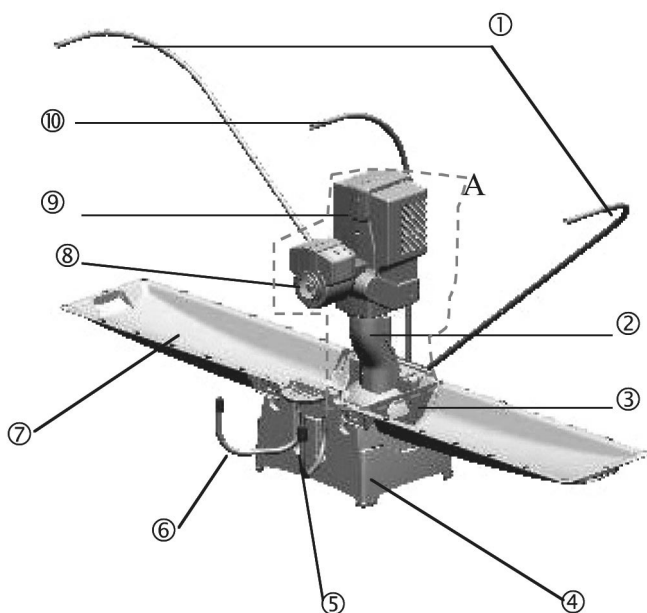

- (1) Left/Right Pipe
- (2) Transparent Cap
- (3) Ball Separator
- (4) Base (Undercarriage or ball service tray)
- (5) Right Pipe
- (6) Left Pipe
- (7) Left/Right Ball collecting tray (ball track)
- (8) Server Head
- (9) Infrared Sensor
- (10) Middle Pipe
- (A) The system (robot server)

## Assembly

To optimize the performance of this robot, make sure to follow the assembly instructions as below:

The assembly of this robot is very easy. No special tools are required. If you follow the following steps you can complete the assembly within 5 minutes.

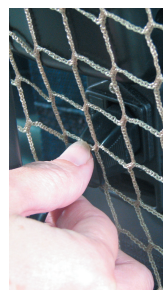

1. When you take the robot from the packing carton, please hold the iron pipe with one hand and the base with the other. The back of the robot server should be face towards the user and be placed on the table.
2. Withdraw the pipes from both sides of the base and insert them into the straight iron tube.
3. Lift the left and the right ball collecting tray then put them down carefully.
4. Pull out the triangle bracket in front of the robot (supporting bracket at the bottom), then open the left and the right pipes.

5. Based on the thickness of the table, attach the appropriate pads to the left and the right pipes in the front. When the table thickness is 25mm use the No. 1 pad, when the table thickness is 21mm use the No. 3/4 pad, when the table thickness is 17mm use the No. 1/2 pad.
6. Load motor on the center trough of Base put 2 screws on the hole, then fasten them.
7. Place your both hands at the sides of the base to lift the whole system and insert the front tubes under the table at 45° while aiming the tip of the triangle clamp to the middle line of the table.
8. Plug one end of the power cord to the robot AC power input and the other to the AC outlet.
9. The system is now ready to operate with the control of the remote controller (See P10-P11).

## Please Note:

If a ball or any object becomes obstruct somewhere, the buzzer will beep for 2 to 3 minutes then the system will start repositioning. Please turn off the power until the problem is solved.

## Disassembly

It takes only 2 minutes to disassemble this system.

1. Unplug the AC power cord.
2. Place your hands beside the base, lift the whole system slightly and pull it back. Then you may place the whole system on the table.
3. Gather the balls from the left and right ball collecting trays in the base, then place the ball separators from the sides to stop the balls from falling.
4. Draw in the left and right pipes and gather them in the base.
5. Return the ball collecting trays upwards to their original positions (both sides).
6. Draw out the pipes of both sides from the iron tubes and insert them to the holes at the left and right sides of the supporting bracket.

A switching power supply is built into the system, to accommodate all international voltages (AC 88V~240V).

- After plugging, the robot server head will rotate to its ready position. When the remote controller is turned off (while aiming at the infrared sensor at the system), the system will also return to its original position.
- Please unplug the AC power cord if the system is not to be in use for a period of time.
- If the left or the right ball collecting tray is taller than the tabletop, the balls will not fall on the table, so the pads should be changed to decrease the angle of elevation.
- Before putting the balls into the machine, please make sure their sizes are standard to avoid possible breakdown of the system. Never use balls other than 40 mm.

## Cleaning and Maintenance

### How to Clean the Shell

A soft piece of cloth is sufficient for moderate soiling. If the system becomes dirty, please prepare a 1:6 solution of soap and water and clean with a soft piece of cloth, then dry with another dry cloth. Never use strong solvents, such as alcohol, benzene or other volatile cleansers.

To avoid accidents, always unplug the power cord of the system while cleaning this device.

### How to Maintain the System

Please wash the table tennis balls regularly to remove dusts and hairs because these can cause a malfunction of the system.

If the balls are distorted, squished or wrongly size, stop using them to prevent further damage to system.

# Solutions for the Balls are Obstructed

## Step1:

Pull out the AC power plug and the power wire of the ball blender device.

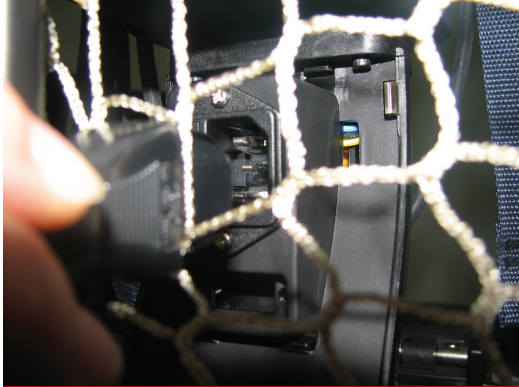

The AC Power plug



The power wire of the ball blender device

## Step2:

Install the ball separation board into the undercarriage. (As figure shown below)



The ball separation board

## Step3:

Evacuate the balls on the undercarriage



## Step4:

Loosen the butterfly shape nut.

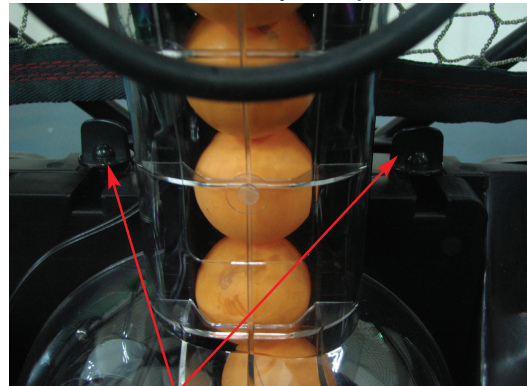

The butterfly shape nut

## Step5:

Lift up the robot. Take out the balls from the undercarriage. Check to see if the balls are squished, distorted or wrongly sized. If so, do not put the balls into the machine.

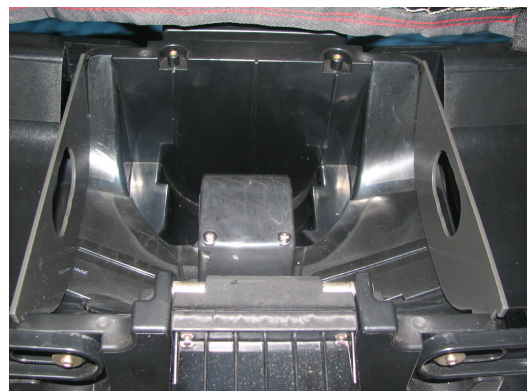

# Brief Instructions for Troubleshooting

## Remarks:

- 1.This device does not require any modification. If any breakdown occurs, check the following to solve problems.
- 2.Until the problem is solved, make sure to turn the power off to avoid damage.
- 3.If your problem is not found in the list, please contact the dealer. Never try to reassemble it by yourself.
- 4.If the ball is obstructed, the system will keep repositioning itself to the default position.

|                   | Problem                                                            | Cause                                                                                                                                                                                                                                                                                                                                                                                             | Solution                                                                                                                                                                                                                                                                                                                                                              |
|-------------------|--------------------------------------------------------------------|---------------------------------------------------------------------------------------------------------------------------------------------------------------------------------------------------------------------------------------------------------------------------------------------------------------------------------------------------------------------------------------------------|-----------------------------------------------------------------------------------------------------------------------------------------------------------------------------------------------------------------------------------------------------------------------------------------------------------------------------------------------------------------------|
| System            | A. System fails to start.                                          | <ol style="list-style-type: none"> <li>1.Power is not turned on.</li> <li>2.Ball Service tray is blocked.</li> <li>3.Remote control distance is too far from the system or there is an obstacle in between.</li> <li>4.No power.</li> <li>5.Failure of remote controller.</li> </ol>                                                                                                              | <ol style="list-style-type: none"> <li>1.Check if the power cord is plugged in.</li> <li>2.Refer to B.</li> <li>3.Shorten the distance of remote control or move away the obstacle. If this does not work out, the system or remote controller could have failed. (Send it to repair center)</li> <li>4.Replace the fuse.</li> <li>5.Refer to D.</li> </ol>           |
|                   | B. Ball service tray is blocked with balls.<br>(Buzzer beeps)      | <ol style="list-style-type: none"> <li>1.Blocked with balls or other objects</li> </ol>                                                                                                                                                                                                                                                                                                           | <ol style="list-style-type: none"> <li>1.blocked with balls – turn off the power first!<br/>Remove the transparent cap and measure the diameter of the ball. Do not use any oversized or flat balls to avoid blockage.</li> <li>2.Blocked with unspecified objects or conflicted with the ball service gear.</li> </ol>                                               |
|                   | C. Weak, abnormal or failed service balls                          | <ol style="list-style-type: none"> <li>1.The transparent cap is not tightly sealed</li> <li>2.There is not any ball on the ball service tray because the ball is blocked in the left/right ball collecting tray.</li> <li>3.The ball service tray is blocked with a ball or other objects.</li> <li>4.Ball too small (38 mm)</li> <li>5.The spring of the ball service tube is broken.</li> </ol> | <ol style="list-style-type: none"> <li>1.Reseal the transparent cap tightly</li> <li>2.Put the ball in the left/right ball collecting tray back to the ball service tray.</li> <li>3.Check the ball service tray and remove the blocked ball or object, if any.</li> <li>4.Use the international standard 40 mm balls.</li> <li>5.Send it to repair center</li> </ol> |
| Remote controller | D. The system works, but does not respond to the remote controller | <ol style="list-style-type: none"> <li>1.The conductive plastic of the remote controller is aging.</li> <li>2.Invalid service modes. under AUTO MODE, only the runtime,ball service frequency and memory modules are available.</li> <li>3.Insufficient battery power for the remote controller.</li> <li>4.Remote controller does not aim at the system correctly.</li> </ol>                    | <ol style="list-style-type: none"> <li>1.Send it to repair center.</li> <li>2.Please refer to the USER'S MANUAL of the remote controller. If problem still exists, send it to repair center.</li> <li>3.Replace with new battery.</li> <li>4.Aim the remote controller at the system directly.</li> </ol>                                                             |
|                   | E. No display on LCD                                               | <ol style="list-style-type: none"> <li>1.Insufficient battery power.</li> <li>2.Opposite battery direction.</li> <li>3.LCD breakdown.</li> </ol>                                                                                                                                                                                                                                                  | <ol style="list-style-type: none"> <li>1.Replace with new battery.</li> <li>2.Check the pole direction of battery.</li> <li>3.Send it to repair center.</li> </ol>                                                                                                                                                                                                    |
|                   | F. Memory function does not work                                   | <ol style="list-style-type: none"> <li>1.Incorrect memory settings.</li> <li>2.PCB failure.</li> </ol>                                                                                                                                                                                                                                                                                            | <ol style="list-style-type: none"> <li>1.Please refer to the USER'S MANUAL P19~21 to restart memory setting.</li> <li>2.Send it to repair center.</li> </ol>                                                                                                                                                                                                          |

